

70 012100

L (mm)	W (mm)	H (mm)	Kg	Pezzi / Pack
41	13	53	0,05	1

Gancio stampato in ferro grezzo H=53
Printed hook in raw iron H=53

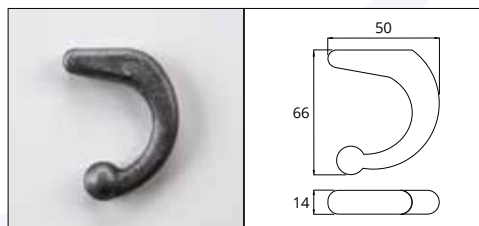

70 012101

L (mm)	W (mm)	H (mm)	Kg	Pezzi / Pack
50	14	66	0,11	1

Gancio stampato in ferro grezzo H=66
Printed hook in raw iron H=66

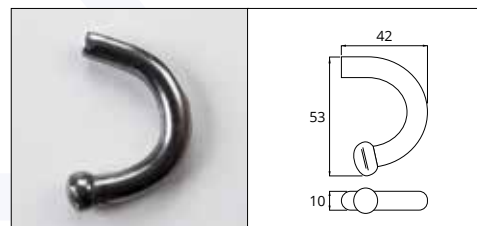

70 012146

L (mm)	W (mm)	H (mm)	Kg	Pezzi / Pack
42	10	53	0,06	1

Gancio tornito zincato H=53
Galvanized turned hook H=53

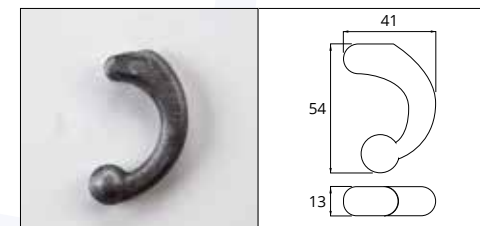

70 012147

L (mm)	W (mm)	H (mm)	Kg	Pezzi / Pack
41	13	54	0,065	1

Gancio inox H=54
Stainless hook H=54

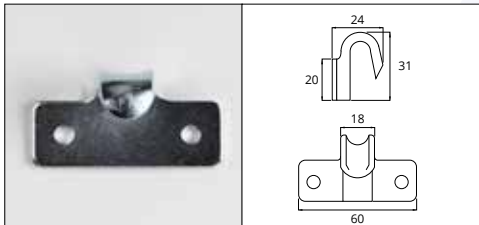

70 012102

L (mm)	W (mm)	H (mm)	Kg	Pezzi / Pack
60	24	31	0,35	1

Gancio zincato
Galvanized hook

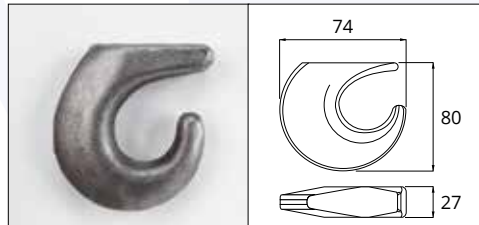

70 012120

L (mm)	W (mm)	H (mm)	Kg	Pezzi / Pack
74	27	80	0,4	1

Gancio traino piccolo
Small tow hook

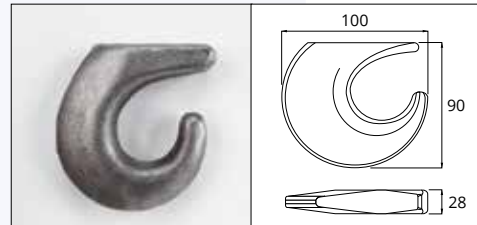

70 012121

L (mm)	W (mm)	H (mm)	Kg	Pezzi / Pack
100	28	90	0,8	1

Gancio traino medio
Medium tow hook

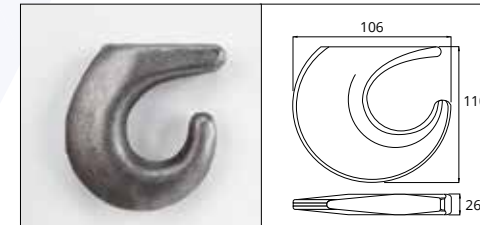

70 012122

L (mm)	W (mm)	H (mm)	Kg	Pezzi / Pack
106	26	110	1,2	1

Gancio traino grande
Big tow hook

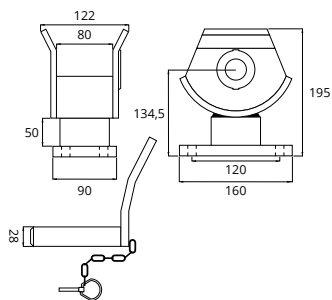

66 0413004

L (mm)	W (mm)	H (mm)	Kg	Pezzi / Pack
160	115	182	5,95	1

Gancio traino fisso tipo Lupo
Fixed tow hook

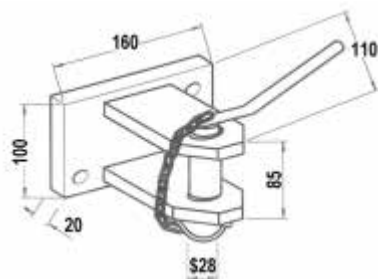

66 0413008

L (mm)	W (mm)	H (mm)	Kg	Pezzi / Pack
160	20	100	4,3	1

Gancio traino tipo Lamborghini
Fixed tow hook