

1 ADR E PANNELLISTICA ADR EQUIPMENTS



V16 - 2024

01. PANNELLI PER ADR • ADR PANELS AND COMPONENTS
02. CARTELLI DI SEGNALAZIONE INGOMBRO POSTERIORE E ECE 70/01 • REAR MARKER PLATES ECE 70/01
03. LIMITI DI VELOCITA' - NASTRI DI DELINEAZIONE VEICOLI - ECE 104 • SPEED LIMITS - ECE 104
04. TRASPORTI ECCEZIONALI • EXCEPTIONAL CONVOY
05. CARTELLI E SEGNALI PER VEICOLI • PANELS (MISCELLANEOUS)
06. PORTATARGA • PLATE HOLDERS
07. SPEGNIFIAMMA • SPARK DAMPERS
08. COMPONENTI ED ACCESSORI PER ADR • ADR COMPONENTS
09. DOTAZIONE DI SOCCORSO ED EMERGENZA ADR • ADR EQUIPMENT
10. ESTINTORI • FIRE EXTINGUISHERS



70 028277/09

L (mm)	H (mm)	Kg	Pezzi / Pack
407	303	0,890	14

Portapannello ADR con linguetta di fermo
ADR panel rack with fixing tang



70 028278

L (mm)	H (mm)	Kg	Pezzi / Pack
398	282	0,860	14

Portanumeri ADR
ADR number holder



70 028159

L (mm)	W (mm)	H (mm)	Kg	Pezzi / Pack
380	43	75	0,4	14

Supporto ad omega fissaggio p/cartelli
300x300 e 407x303
Fixing omega rest panel 300x300
and 407x303



70 028447

Linguetta di fermo ADR 2009 (Conf. 10 Pz.)
Adatta per **70 028276/09** e **70 028277/09**
Fixing tang ADR 2009 (Pack 10 pieces)
Suitable for **70 028276/09** and **70 028277/09**

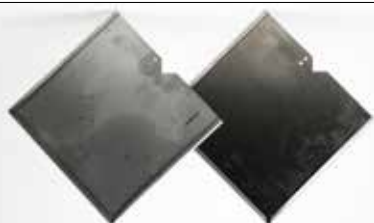

70 028192V01

L (mm)	W (mm)	H (mm)	Kg	Pezzi / Pack
715	36	420	2,2	1

Portacartello doppio inox, 4 asole di interasse 205 ± 6 e ø 9
Double stainless panel rack, 4 loops with wheelbase 205 ± 6 and ø 9



70 028445V01

L (mm)	W (mm)	H (mm)	Kg	Pezzi / Pack
1016	36	420	3,3	1

Portacartello triplo inox, 4 asole di interasse 205 ± 6 e ø 9
Triple stainless panel rack, 4 loops with wheelbase 205 ± 6 and ø 9



70 028193

L (mm)	W (mm)	H (mm)	Kg	Pezzi / Pack
300	1	300	0,24	1

Piastra in alluminio per incollaggio adesivi ADR
Aluminium plaque for fixing ADR adhesives



70 028237

L (mm)	W (mm)	H (mm)	Kg	Pezzi / Pack
730	/	30	0,85	1

Guida inox nuda per segnaletica ADR
Stainless bare slide for ADR sign system



70 028309

L (mm)	W (mm)	H (mm)	Kg	Pezzi / Pack
285	/	30	0,33	1

Guida inox nuda per segnaletica ADR
Stainless bare slide for ADR sign system



70 028238

L (mm)	W (mm)	H (mm)	Kg	Pezzi / Pack
/	/	150	0,29	1

Collare inox per tubo
Stainless steel collar for tube



70 028475

L (mm)	W (mm)	H (mm)	Kg	Pezzi / Pack
/	/	200	0,35	1

Collare inox per tubo
Stainless steel collar for tube



70 028308

L (mm)	W (mm)	H (mm)	Kg	Pezzi / Pack
285	/	150	0,59	1

Guida inox singola per segnaletica ADR
Stainless single slide for ADR sign system



70 028307

L (mm)	W (mm)	H (mm)	Kg	Pezzi / Pack
730	/	150	1,14	1

Guida inox doppia per segnaletica ADR
Stainless single double for ADR sign system



70 028230

L (mm)	W (mm)	H (mm)	Kg	Pezzi / Pack
150	/	350	0,25	1

Supporto in inox per portacartello 70 028158
Stainless support panel rack 70 028158

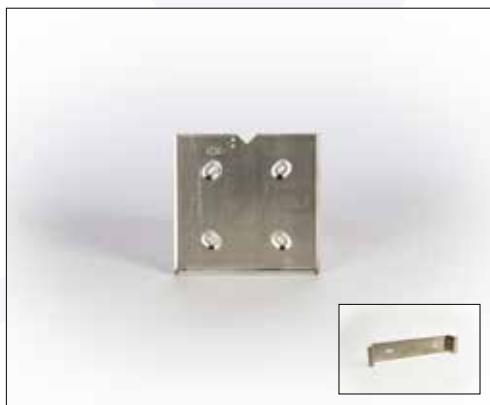

Codice / Code	Descrizione / Description	L (mm)	W (mm)	H (mm)	Peso • Weight	Pezzi / Pack
70 028600/X09	Portacartello inox, 4 asole di interasse 205 ± 6 e $\varnothing 9$ + linguetta di fermo 70028447 Stainless panel rack, 4 loops, with wheelbase 205 ± 6 and $\varnothing 9$ and fixing tang 70 028447	300	0,8	300	0,550	1
70 028600/Z09	Portacartello zincato, 4 asole di interasse 205 ± 6 e $\varnothing 9$ + linguetta di fermo 70028447 Zinc panel rack, 4 loops, with wheelbase 205 ± 6 and $\varnothing 9$ and fixing tang 70 028447	300	1	300	0,610	1

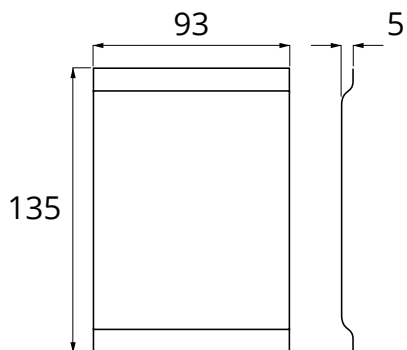
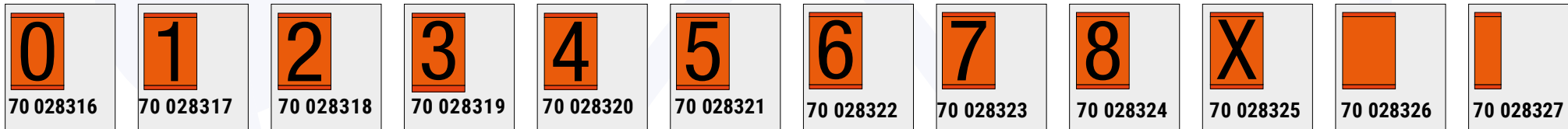

Piegati / Bent

Codice / Code	Descrizione / Description	Contenuto / Contents	Peso / Weight
70 028 314	Set 14 pezzi petroliferi ADR * (Su richiesta) Set of 14 Oil-bearing ADR numbers * (On demand)	0 = 2 pz, 1 = 1 pz, 2 = 2 pz, 3 = 3 pz, 5 = 1 pz, 6 = 2 pz, 7 = 1 pz, blank = 2 pz	0,730
70 028 312	Set 39 pezzi chimici ADR*	0 = 3 pz, 1 = 3 pz, 2 = 3pz, 3 = 3pz, 4 = 3 pz, 5 = 3 pz, 6 = 4 pz, 7 = 3 pz, 8 = 3 pz, X = 1 pz, 1/1 Blank = 6 pz, 1/2 Blank = 4 pz.	2,030

* Confezionati in custodia nylon **70 028236** • Packed in nylon holder **70 028236**

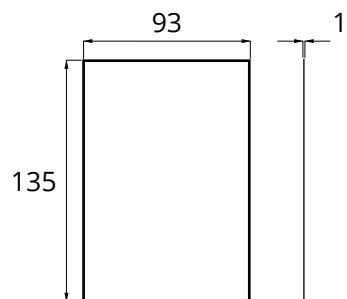
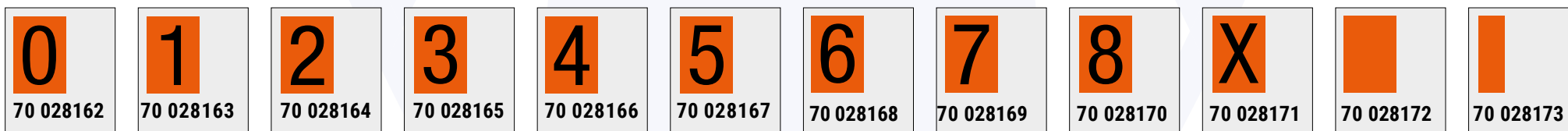

Piani / Plans

Codice / Code	Descrizione / Description	Contenuto / Contents	Peso / Weight
70 028151	Set 37 pezzi chimici * Set of 37 Chemical numbers *	0 = 3 pz, 1 = 3 pz, 2 = 3 pz, 3 = 3 pz, 4 = 3 pz, 5 = 3 pz, 6 = 4 pz, 7 = 3 pz, 8 = 3 pz, X = 1 pz, blank = 8 pz	1,920

* Confezionati in custodia nylon **70 028236** • Packed in nylon holder **70 028236**



70 029104

L (mm)	W (mm)	H (mm)	Kg	Pezzi / Pack
486	1	109	0,05	1

Targa ripetitrice gialla in ferro
Licence plate duplicate in yellow iron



70 028236

L (mm)	H (mm)	Kg	Pezzi / Pack
398	282	0.03	10

Custodia nera in nylon per serie di numeri
Black nylon holder for set of numbers



70 028404

L (mm)	H (mm)	Kg	Pezzi / Pack
400	300	0,470	1

Borsa in nylon con fondo rigido per pannelli
imbossati
Nylon bag with rigid bottom for panels



70 028160

L (mm)	H (mm)	Kg	Pezzi / Pack
407	303	0,169	10

Fodera per pannello in nylon
Nylon panel cover



70 028148

L (mm)	H (mm)	Kg	Pezzi / Pack
400	300	1,4	1

Pannello zincato per prodotti petroliferi
Zinc panel for oil-bearing products



70 028420

L (mm)	H (mm)	Kg	Pezzi / Pack
398	282	0,860	14

Cartello New ADR bi-codice per 33/1203 e
30/1202
Bi-code panel New ADR for 33/1203 and
30/1202

22
1951

Codice / Code	Descrizione / Description	Numeri / Number	Peso / Weight	Pack
70 028186/NA	Pannello ADR Argon Liquido ADR sign - Liquid Argon	22 / 1951	0,760	1
70 028187/NA	Pannello ADR Azoto Liquido ADR sign - Liquid Nitrogen	22 / 1977	0,760	1
70 028188/NA	Pannello ADR Biossido di Carbonio ADR sign - Carbon Bioxide	22 / 2187	0,760	1
70 028235/NA	Pannello ADR Butano ADR sign - Butane	23 / 1011	0,760	1
70 028261/NA	Pannello ADR Idrogeno Compresso ADR sign - Compressed Hydrogen	23 / 1049	0,760	1
70 028183/NA	Pannello ADR GPL ADR sign - GPL	23 / 1965	0,760	1
70 028185/NA	Pannello ADR Gas Naturale ADR sign - Natural Gas	23 / 1971	0,760	1
70 028184/NA	Pannello ADR Propano Liquido ADR sign - Liquid Propane	23 / 1978	0,760	1
70 028135/NA	Pannello ADR Gasolio ADR sign - Gas Oil	30 / 1202	0,760	1
70 028136/NA	Pannello ADR Cherosene ADR sign - Kerosene	30 / 1223	0,760	1
70 028190/NA	Pannello ADR ossigeno Liquido ADR sign - Liquid Oxygen	225 / 1073	0,760	1
70 028191/NA	Pannello ADR ossido etilene	236 / 1040	0,760	1

Codice / Code	Descrizione / Description	Numeri / Number	Peso / Weight	Pack
70 028270/NA	Pannello ADR Gasolio per Jet - 1997 ADR sign - Gas Oil for Jet - 1997	30 / 1863	0,760	1
70 028269/NA	Pannello ADR Gasolio Denso - 1997 ADR sign - Gas Oil Thick - 1997	30 / 3256	0,760	1
70 028134/NA	Pannello ADR Benzina ADR sign - Petrol	33 / 1203	0,760	1
70 028297/NA	Pannello ADR Petrolio Grezzo ADR sign - Raw Petrol	33 / 1267	0,760	1
70 028284/NA	Pannello ADR Benzina Avio ADR sign - Avio Petrol	33 / 1268	0,760	1
70 028280/NA	Pannello ADR Olio Combustibile ADR sign - Fuel Oil	90 / 3082	0,760	1
70 028268/NA	Pannello ADR Bitume ADR sign - Bitumen	99 / 3257	0,760	1
70 028225/NA	Pannello ADR Etilene Refrigerato ADR sign - Refrigerated Ethylene	223 / 1038	0,760	1
70 028189/NA	Pannello ADR Idrogeno Liquido ADR sign - Liquid Hydrogen	223 / 1966	0,760	1
70 028226/NA	Pannello ADR Gas Naturale Liquido ADR sign - Liquid Natural Gas	223 / 1972	0,760	1
70 028282/NA	Pannello ADR ammoniac	268 / 1005	0,760	1
70 028453/NA	Pannello ADR materiale pericolo ambiente acquatico	90 / 3077	0,760	1

30

1208

Codice / Code	Descrizione / Description	Numeri / Number	mm
70 028450	Pellicola adesiva tipo ADR/ONU	63/2929	400 x 300
70 028451	Pellicola adesiva tipo ADR/ONU	336/1992	400 x 300
70 028452	Pellicola adesiva tipo ADR/ONU	90/3082	400 x 300
70 028454	Pellicola adesiva tipo ADR/ONU	90/3077	400 x 300
70 028458	Pellicola adesiva tipo ADR/ONU	30/325	400 x 300
70 028457	Pellicola adesiva tipo ADR/ONU	30/1208	400 x 300
70 028459	Pellicola adesiva tipo ADR/ONU	33/1208	400 x 300
70 028460	Pellicola adesiva tipo ADR/ONU	36/1992	400 x 300
70 028456	Pellicola adesiva tipo ADR/ONU	40/3175	400 x 300
70 028461	Pellicola adesiva tipo ADR/ONU	80/1794	400 x 300
70 028462	Pellicola adesiva tipo ADR/ONU	80/1824	400 x 300
70 028463	Pellicola adesiva tipo ADR/ONU	80/1830	400 x 300
70 028464	Pellicola adesiva tipo ADR/ONU	80/2794	400 x 300
70 028465	Pellicola adesiva tipo ADR/ONU	80/3082	400 x 300
70 028466	Pellicola adesiva tipo ADR/ONU	80/3266	400 x 300
70 028468	Pellicola adesiva tipo ADR/ONU	30/1863	400 x 300
70 028470	Pellicola adesiva tipo ADR/ONU	90/2212	400 x 300
70 028471	Pellicola adesiva tipo ADR/ONU	90/2590	400 x 300
70 028472	Pellicola adesiva tipo ADR/ONU	40/1325	400 x 300
70 028473	Pellicola adesiva tipo ADR/ONU	80/3262	400 x 300
70 028474	Pellicola adesiva tipo ADR/ONU	60/2811	400 x 300
70 028477	Pellicola adesiva tipo ADR/ONU	20/3159	400 x 300
70 028478	Pellicola adesiva tipo ADR/ONU	80/3264	400 X 300
70 028479	Pellicola adesiva tipo ADR/ONU	60/3288	400 X 300
70 028484	Pellicola adesiva tipo ADR/ONU	22/1977	400 X 300
70 028485	Pellicola adesiva tipo ADR/ONU	225/1073	400 X 300



70 028212

L (mm)	H (mm)	Kg	Pezzi / Pack
400	300	0,05	10

Pellicola adesiva con riga nera centrale
Adhesive film with central black stripe

Si eseguono altri codici su richiesta

Additional codes are made on request



70 028414

L (mm)	W (mm)	H (mm)	Kg	Pezzi / Pack
400	1	300	0,36	1

Cartello in alluminio classe 2
Aluminium sign class 2



70 028211

L (mm)	W (mm)	H (mm)	Kg	Pezzi / Pack
400	1	300	0,05	1

Pellicola adesiva con bordo nero
Orange Adhesive with black border



70 028415

L (mm)	W (mm)	H (mm)	Kg	Pezzi / Pack
400	1	300	0,38	1

Cartello in alluminio piega orizzontale classe 2
Folding horizontal aluminium sign class 2



70 028416

L (mm)	W (mm)	H (mm)	Kg	Pezzi / Pack
400	1	300	0,39	1

Cartello in alluminio piega verticale classe 2
Folding vertical aluminium sign class 2



70 028455

L (mm)	W (mm)	H (mm)	Kg	Pezzi / Pack
400	30	300	0,74	1

Cartello in alluminio piega verticale con omega di fissaggio - classe 2
Folding vertical aluminium sign omega rest - class 2



70 028293

L (mm)	W (mm)	H (mm)	Kg	Pezzi / Pack
300	1	120	0,2	1

Cartello in alluminio piega verticale - classe 2
Folding vertical aluminium sign - class 2



70 028292

L (mm)	W (mm)	H (mm)	Kg	Pezzi / Pack
300	1	120	0,18	1

Cartello in alluminio fisso - classe 2
Fix aluminium sign - class 2





70 028267

L (mm)	W (mm)	H (mm)	Kg	Pezzi / Pack
450	28	60	0,35	1

Supporto ad omega in acciaio inox con clip
Stainless steel omega rest with clips



70 028257
Clips di ricambio in acciaio inox
Spare clips Inox

 <p>70 028208 70 028208/R</p> <p>CLASSE 1.1 - 1.2 - 1.3 Esplosivi CLASS 1.1 - 1.2 - 1.3 Explosive</p>	 <p>70 028209 70 028209/R</p> <p>CLASSE 1.4 Esplosivi CLASS 1.4 Explosive</p>	 <p>70 028210 70 028210/R</p> <p>CLASSE 1.5 Esplosivi CLASS 1.5 Explosive</p>	 <p>70 028405 70 028405/R</p> <p>CLASSE 1.6 Esplosivi CLASS 1.6 Explosive</p>	 <p>70 028406 70 028406/R</p> <p>CLASSE 2 Fiamma CLASS 2 Flame</p>	 <p>70 028194 70 028194/R</p> <p>CLASSE 2 Gas compresso non infiammabile CLASS 2 Non-flammable compressed gas</p>	 <p>70 028407 70 028407/R</p> <p>CLASSE 2 Tossico CLASS 2 Toxic</p>	 <p>70 028139 70 028139/R</p> <p>CLASSE 3 Infiammabili CLASS 3 Inflammable</p>
 <p>70 028195 70 028195/R</p> <p>CLASSE 4.1 Solidi infiam- mabili CLASS 4.1 Inflammable solid</p>	 <p>70 028196 70 028196/R</p> <p>CLASSE 4.2 Sostanze infiammabili spontanee CLASS 4.2 Spontaneous inflammable substances</p>	 <p>70 028197 70 028197/R</p> <p>CLASSE 4.3 Sviluppo gas infiammabile a contatto con acqua / CLASS 4.3 Generation of inflammable gas</p>	 <p>70 028386 70 028386/R</p> <p>CLASSE 5.1 Comburenti o perossidi organici CLASS 5.1 Comburents or organic peroxide</p>	 <p>70 028387 70 028387/R</p> <p>CLASSE 5.2 Sostanze ossi- danti o perossidi organici CLASS 5.2 Oxiding substances or organic peroxide</p>	 <p>70 028199 70 028199/R</p> <p>CLASSE 6.1 Tossici CLASS 6.1 Toxic</p>	 <p>70 028201 70 028201/R</p> <p>CLASSE 6.2 Pericolo biologico CLASS 6.2 Biological danger</p>	 <p>70 028202 70 028202/R</p> <p>CLASSE 7/A Radioattivi cat.1 CLASS 7/A Radioactives cat.1</p>
 <p>70 028203 70 028203/R</p> <p>CLASSE 7/B Radioattivi cat.2 CLASS 7/B Radioactives cat.2</p>	 <p>70 028204 70 028204/R</p> <p>CLASSE 7/C Radioattivi cat.3 CLASS 7/C Radioactives cat.3</p>	 <p>70 028444 70 028444/R</p> <p>Quantità limitata Limited quantity</p>	 <p>70 028206 70 028206/R</p> <p>CLASSE 8 Corrosivi CLASS 8 Corrosives</p>	 <p>70 028207 70 028207/R</p> <p>CLASSE 9 Pericolosità generica CLASS 9 General danger</p>	 <p>70 028438 70 028438/R</p> <p>Materie pericolose per l'ambiente Environmentally hazard substance mark</p>	<p>Dimensioni adesivi: 300x300 (mm)</p> <p>Adhesives dimensions 300x300 (mm)</p>	<p>Dimensioni adesivi con codice /R: 100x100 (mm)</p> <p>Adhesive dimensions with /R code: 100x100 (mm)</p>
 <p>70 028480</p> <p>Pericolo asfissia, 150x200 Disponibile a richiesta in lingua inglese o tedesca. Asphyxiation danger 150x200 We can provide it in English or in German on demand</p>	 <p>70 028481</p> <p>Classe 1 Trasporto idroge- no 110x80 Class 1 Hydrogen 110x80</p>	 <p>70 028476</p> <p>Adesivo angoli ciechi, 170x250 Sticker "Angles Morts" 170x250</p>					

70 028296

Adesivo con scritta ESTINTORE
Adhesive with inscription ESTINTORE

L (mm)	W (mm)	H (mm)	Kg	Pz/ Pack
140	1	50	0,02	1

ESTINTORE
FIRE EXTINGUISHER

70 028275

Segnale adesivo triangolare
Adhesive triangular signal

L (mm)	W (mm)	H (mm)	Kg	Pezzi / Pack
300	1	260	0,05	1



70 028274

Segnale adesivo con triangolo stampato
Adhesive signal with printed triangle

L (mm)	W (mm)	H (mm)	Kg	Pezzi / Pack
300	1	300	0,06	1



70028439/IT - Istruzioni di sicurezza Italiano

70028439/FR - Istruzioni di sicurezza Francese

70028439/DE - Istruzioni di sicurezza Tedesco

70028439/EN - Istruzioni di sicurezza Inglese