

# 4 PARAFANGHI MUDGUARDS



V15 - 2024

01. PARAFANGHI TERMOPLASTICI • THERMOPLASTIC MUDGUARDS
02. PARAFANGHI METALLICI • STEEL AND STAINLESS MUDGUARDS
03. PARAFANGHI 2/3 ASSI • 2/3 AXIS MUDGUARDS
04. STAFFAGGIO PARAFANGHI • BRACKETS FOR MUDGUARDS



Parafanghi termoplastici ad iniezione  
Mudguards injection moulding

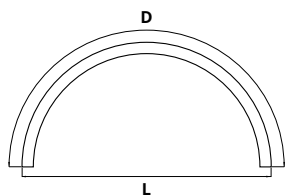

Codice / Code	W (mm)	L (mm)	D (mm)	Descrizione / Description	Kg	Pezzi / Pack
<b>70 008201</b>	270	880	1380	Liscio / Smooth	1,35	1
<b>70 008201G</b>	270	880	1380	Goffrato / Rough	1,30	1
<b>70 008216</b>	380	730	1140	Liscio / Smooth	1,20	1
<b>70 008202</b>	400	880	1380	Liscio / Smooth	2,00	1
<b>70 008202G</b>	400	880	1380	Goffrato / Rough	2,00	1
<b>70 008203</b>	450	880	1380	Liscio / Smooth	2,10	1
<b>70 008203G</b>	450	880	1380	Goffrato / Rough	2,10	1
<b>70008203/J*</b>	450	740	1360	Liscio / Smooth	1,80	1
<b>70 008205</b>	450	1300	1900	Liscio / Smooth	3,20	1
<b>70 008205G</b>	450	1300	1900	Goffrato / Rough	3,20	1
<b>70 008206</b>	450	1340	2100	Liscio / Smooth	3,50	1
<b>70 008206G</b>	450	1340	2100	Goffrato / Rough	3,50	1
<b>70 008207</b>	500	1000	1570	Liscio / Smooth	2,60	1
<b>70 008215</b>	550	1000	1600	Liscio / Smooth	2,80	1
<b>70 008103</b>	550	1150	1780	Liscio / Smooth	3,27	1
<b>70 008104</b>	600	1150	1750	Liscio / Smooth	3,40	1
<b>70 008108</b>	650	1250	1800	Liscio / Smooth	4,80	1
<b>70 008208</b>	650	1300	1900	Liscio / Smooth	4,40	1
<b>70 008209</b>	650	1340	2100	Liscio / Smooth	4,85	1
<b>70 008209G</b>	650	1340	2100	Goffrato / Rough	4,85	1
<b>70008109G</b>	700	1300	1900	Goffrato / Rough	5,50	1

\*Fino esaurimento scorte / \*Until stocks Ist



Codice / Code	W (mm)	L (mm)	D (mm)	H (mm)	M (mm)	Kg	Pezzi / Pack
<b>70 008217</b>	280	900	1450	450	440	2.30	1
<b>70 008214</b>	450	900	1500	460	400	2.80	1
<b>66 2719114/BIS</b>	470	900	1460	450	420	2.80	1
<b>70 008164</b>	300	900	1500	450	400	1.85	1

Parafango sommità piatta ad iniezione  
Injection flat top mudguard

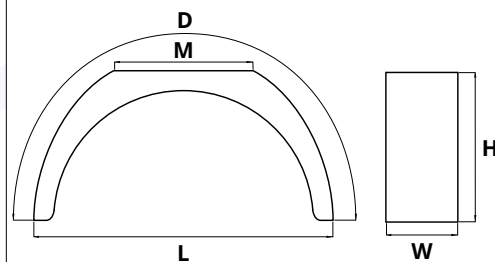

Codice / Code	W (mm)	L (mm)	D (mm)	H (mm)	M (mm)	Kg	Pezzi / Pack
<b>70 008163</b>	550	1100	1870	460	650	2.8	1
<b>70 008162</b>	500	1050	1740	450	500	2.8	1

Parafango sommità piatta rotazionale  
Rotational flat top mudguard

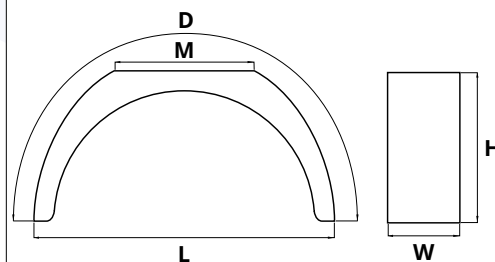



Codice / Code	W (mm)	D (mm)	Tipo / Type	Kg	Pezzi / Pack
<b>70 008250</b>	450	700	Liscio / Smooth	1,25	1
<b>70 008251</b>	450	800	Liscio / Smooth	1,35	1
<b>70 008253</b>	500	700	Liscio / Smooth	1,40	1
<b>70 008254</b>	650	650	Liscio / Smooth	1,30	1
<b>70 008255</b>	650	700	Liscio / Smooth	1,35	1
<b>70 008256</b>	650	800	Liscio / Smooth	1,60	1

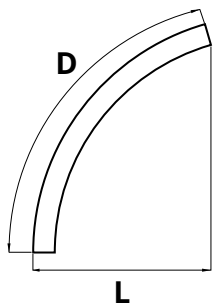

Parafanghi termoplastici ad iniezione  
Injection moulding mudguards

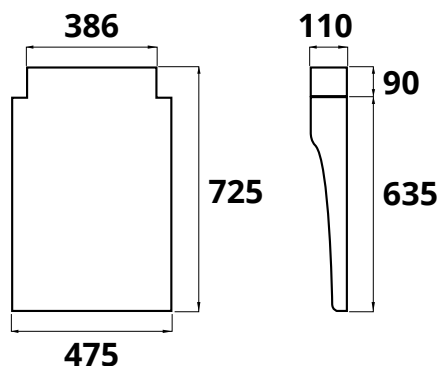

Codice/Code	Descrizione/Description	L (mm)	W (mm)	H (mm)	Kg	Pezzi / Pack
<b>70 020132</b>	Parafango verticale con antispray omologato Vertical mudguard with homologated antispray	475	110	725	1,709	1
<b>70 0022300/2</b>	Antispray per rendere 70 020132 omologato EU 109/2011 Antispray to make 70 020132 EU 109/2011 homologated	410	420		0,944	1

#### Montaggio / Mounting:

**A) 70 020-132** Parafango verticale / Vertical mudguard

**B) 70 022-300/2** Antispray per rendere il parafango omologato secondo la normativa (CEE 91/226)  
Antispray that must be matched with the mudguard to get an homologated device (CEE 91/226)

**C) 70 022-128** Bandella omologata con supporto PVC orizzontale  
Homologated band with PVC horizontal connection

**C) 70 022-129** Bandella omologata con supporto PVC verticale  
Homologated band with PVC vertical connection

**C) 70 022-131** Bandella omologata con supporto alluminio orizzontale  
Homologated band with aluminium horizontal connection

- **90 025-131/M** Staffa zincata / Zinch coated bracket

- **70 025-154** Tubi di supporto / Tube

- **90 115-138** Staffa tpi  $\phi$  42 / Bracket  $\phi$  42

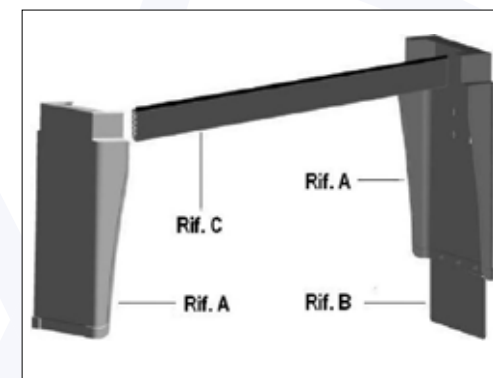



Parafanghi zinco gomma  
Galvanized steel mudguard with rubber edge

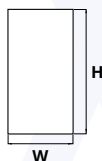
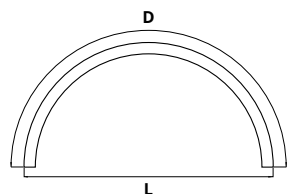

Codice / Code	W (mm)	L (mm)	D (mm)	Descrizione / Description	Kg	Pezzi / Pack
<b>70 019104</b>	220	820	1250	Zinco Gomma	1,90	1
<b>70 019105</b>	250	910	1460	Zinco Gomma	2,75	1
<b>66 2715055</b>	280	880	1300	Zinco Gomma	2,80	1
<b>66 2715054</b>	350	700	1100	Zinco Gomma	4,00	1
<b>70 019106</b>	400	800	1260	Zinco Gomma	3,80	1
<b>66 2715030/BIS</b>	400	860	1360	Zinco Gomma	3,80	1
<b>70 019122</b>	425	880	1360	Zinco Gomma	4,25	1
<b>70 019107</b>	450	900	1520	Zinco Gomma	4,75	1
<b>66 2715053</b>	450	880	1360	Zinco Gomma	5,00	1
<b>70019126</b>	450	1340	2100	Zinco Gomma	7,60	1
<b>70 019123</b>	500	900	1410	Zinco Gomma	5,20	1
<b>70 019108</b>	500	980	1570	Zinco Gomma	5,45	1
<b>70 019110</b>	500	1100	1600	Zinco Gomma	5,60	1
<b>70 019109</b>	550	1000	1570	Zinco Gomma	6,00	1
<b>70 019111</b>	550	1100	1700	Zinco Gomma	6,50	1
<b>70 019112</b>	600	1115	1800	Zinco Gomma	7,50	1
<b>70 019100</b>	650	1115	1800	Zinco Gomma	8,50	1
<b>70 019113</b>	600	1260	2000	Zinco Gomma	8,35	1
<b>70 019101</b>	550	1260	2000	Zinco Gomma	7,65	1
<b>70 019102</b>	600	1340	2100	Zinco Gomma	8,75	1
<b>70 019103</b>	650	1340	2100	Zinco Gomma	9,50	1





Curva zinco gomma  
Galvanized steel with rubber edge

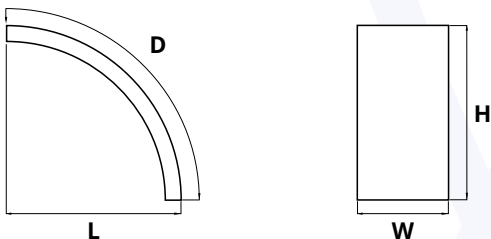

Codice / Code	W (mm)	L (mm)	D (mm)	Descrizione / Description	Kg	Pezzi / Pack
<b>70 019209</b>	500		700	Zinco gomma	2,80	1
<b>70 019210</b>	500		800	Zinco gomma	3,20	1
<b>70 019207</b>	600		700	Zinco gomma	3,40	1
<b>70 019208</b>	600		800	Zinco gomma	3,80	1
<b>70 019206</b>	650		650	Zinco gomma	3,40	1
<b>70 019205</b>	650		800	Zinco gomma	3,90	1



Curva Interflex inox gomma fiorettato  
Stainless steel rubber half-mudguard with texture and rubber edge

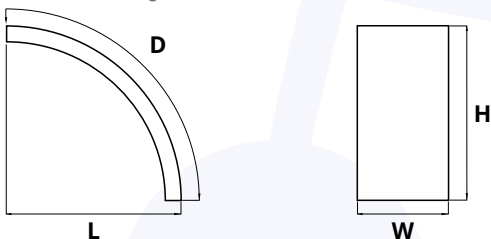

Codice / Code	W (mm)	L (mm)	D (mm)	Descrizione / Description	Kg	Pezzi / Pack
<b>66 2717026</b>	500		700	Inox fiore gomma	3,40	1
<b>66 2717027</b>	500		800	Inox fiore gomma	3,60	1
<b>66 2717018</b>	600		700	Inox fiore gomma	3,80	1
<b>66 2717020</b>	650		800	Inox fiore gomma	4,00	1
<b>66 2717029</b>	650		700	Inox fiore gomma	5,20	1





Curva Interflex inox gomma

Stainless steel rubber half-mudguard with rubber edge

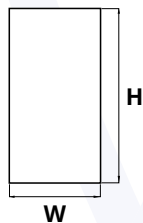
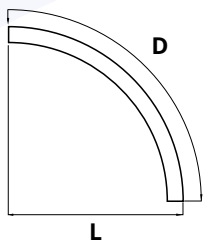

Codice / Code	W (mm)	L (mm)	D (mm)	Descrizione / Description	Kg	Pezzi / Pack
<b>66 2717024*</b>	500		700	Inox gomma	3,20	1
<b>66 2717025*</b>	500		800	Inox gomma	3,50	1
<b>66 2717028*</b>	650		700	Inox gomma	3,20	1
<b>66 2717010*</b>	650		800	Inox gomma	4,00	1

\* Su richiesta / On demand



Codice / Code	W (mm)	L (mm)	D (mm)	Descrizione / Description	Kg	Pezzi / Pack
<b>70 019152</b>	650	2740	3500		15,80	1
<b>70 019155</b>	650	4100	4950		22,40	1

**Parafanghi 2/3 assi zinco gomma**  
2/3 axles mudguards in galvanized steel with rubber edge



Codice / Code	W (mm)	L (mm)	D (mm)	Descrizione / Description	Kg	Pezzi / Pack
<b>66 2717015</b>	650	2740	3500	Inox liscio gomma	11,00	1

**Parafanghi 2/3 assi inox liscio gomma**  
2/3 axles mudguards in stainless steel with rubber edge



Codice / Code	W (mm)	L (mm)	D (mm)	Descrizione / Description	Kg	Pezzi / Pack
<b>66 2717017</b>	650	2740	3500	Inox fiore gomma	13,00	1

**Parafanghi 2/3 assi inox fiorettato gomma**  
2/3 axles mudguards in stainless steel with texture and rubber edge

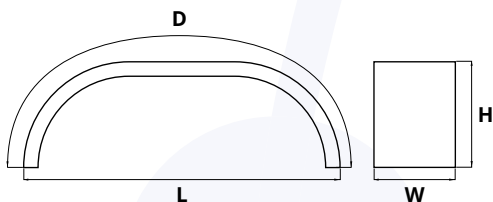



Codice / Code	L (mm)	H (mm)	W (mm)	D (mm)	Descrizione / Description	Kg	Pezzi / Pack
<b>70 020100</b>	2720	640	650	3500	Acciaio 20/10 Steel 2mm	35	1

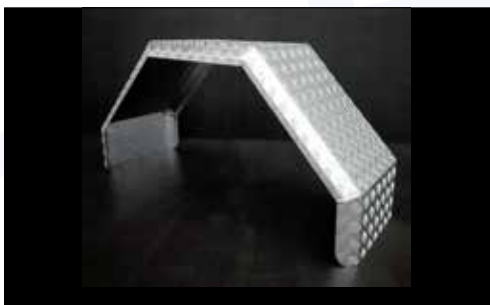

Codice / Code	L (mm)	H (mm)	W (mm)	D (mm)	Descrizione / Description	Kg	Pezzi / Pack
<b>66 2721001</b>	2740	665	650	3500	Alluminio mandorlato Aluminium checker plate		1
<b>66 2721002</b>	1400	710	650	2300	Alluminio mandorlato Aluminium checker plate		1

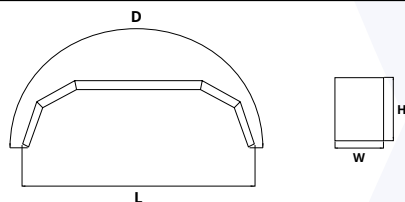

Parafanghi spigolati tipo cava in lamiera mandorlata (66 2721001) o in acciaio di spessore 20/10 (70 020100)  
Aluminium checker plate and steel mudguards

A richiesta, realizziamo anche parafanghi a disegno  
Tailor made mudguards available on demand



Codice / Code	L (mm)	W (mm)	H (mm)	Descrizione / Description	Kg	Pezzi / Pack
<b>70 025131M</b>	340	42	88	Magnelis / Magnelis	0,55	24
<b>70 025132</b>	340	42	88	Verniciata nera / Black cataforesis	0,55	50
<b>70 025134</b>	340	42	88	Acciaio inox / Stainless steel	0,55	50

Staffa regolabile con viteria (inox o zincata) compresa nella confezione, per tubi del diametro di 42 mm.

Adjustable bracket with stainless or galvanized steel screws and bolts included, for diameter 42 mm.



Codice / Code	Descrizione / Description
<b>80LR650*</b>	Supporto parafango fisso zincato più viteria misure 350 x 45 / peso 0,80 kg

\*Su richiesta / On demand



Codice / Code	Ø	L(mm)	Kg	Pezzi / Pack
<b>70 025149</b>	42	360	0,206	50
<b>70 025175</b>	54	260	0,285	50

Codice / Code	Ø	Descrizione / Description
<b>70 025149/1</b>	42	Occhiello di ricambio

Staffa regolabile in PVC con viteria compresa nella confezione.

PVC adjustable bracket with screws and bolts included.



Codice / Code	L (mm)	W (mm)	H (mm)	Descrizione / Description	Kg	Pezzi / Pack
<b>70 025102</b>	750	80	110	Zincato a freddo / Cold galvanized	2,00	1
<b>70 025103</b>	540	80	110	Zincato a freddo / Cold galvanized	1,80	1
<b>70 025147</b>	750	80	110	Inox / Stainless	2,00	1

Supporto parafango. Tubo  $\varnothing 42,4$  mm. Flangia 4 fori rettangolare interasse 80 x 55 saldata spessore 4 mm. Adatto a staffe in metallo e plastica.  
Support tube for mudguard. Tube  $\varnothing 42,4$  mm. Welded-on flange 4 holes, spacing 80 x 55, thickness 4 mm. Suitable for steel and plastic brackets.

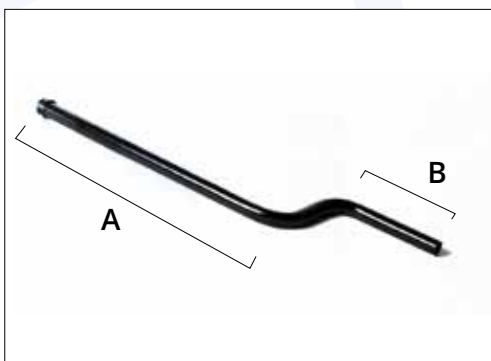

Codice / Code	L (mm)	A (mm)	B (mm)	Kg	Pezzi / Pack
<b>70 025152</b>	770	500	150	1,75	1
<b>70 025157</b>	545	320	150	1,47	1
<b>70 025152Z</b>	800	500	150	1,47	1

Supporto doppia curva in acciaio verniciato nero + cataforesi. Tubo  $\varnothing 42$  mm spessore 2 mm. Flangia circolare con fissaggio ad una vite M18 x 50. Adatto a staffe in metallo e plastica.

Support tube for mudguard, black painted steel + EPD coating.  $\varnothing 42$  mm thickness 2 mm. Circular flange with one fixing screw M18 x 50. Suitable for steel and plastic brackets.



Codice / Code	L (mm)	A (mm)	B (mm)	Kg	Pezzi / Pack
<b>70 025153</b>	800			1,70	1
<b>70 025154</b>	550			1,45	1
<b>70 025153Z</b>	800			1,45	1

Supporto dritto in acciaio verniciato nero + cataforesi. Tubo  $\varnothing 42$  mm spessore 2 mm. Flangia circolare con fissaggio ad una vite M18 x 50. Adatto a staffe in metallo e plastica.

Support tube for mudguard, black painted steel + EPD coating.  $\varnothing 42$  mm thickness 2 mm. Circular flange with one fixing screw M18 x 50. Suitable for steel and plastic brackets.



Codice / Code	L (mm)	Descrizione / Description	Tipo / Type	Kg	Pezzi / Pack
<b>70 025140</b>	750	Supporto per parafango con tubo ø42 mm. Support tube for mudguard ø42 mm.	Composito / Thermo set	0,590	1
<b>70 025141</b>	580	Supporto per parafango con tubo ø42 mm. Support tube for mudguard ø42 mm.	Composito / Thermo set	0,425	1
<b>70 025150</b>	750	Supporto per parafango con tubo ø42 mm. Support tube for mudguard ø42 mm.	Acciaio zincato / Zinc plated	1,100	1
<b>70 025151</b>	545	Supporto per parafango con tubo ø42 mm. Support tube for mudguard ø42 mm.	Acciaio zincato / Zinc plated	0,810	1



Codice / Code	Descrizione / Description	Tipo / Type	Kg	Pezzi / Pack
<b>70 070078</b>	Manicotto per tubo ø42 mm. Tube holder ø42 mm.	Nylon / Nylon	0,230	1
<b>70 070078/FV</b>	Manicotto per tubo ø42 mm. Tube holder ø42 mm.	Nylon + fibra di vetro / Nylon + fibreglass	0,250	1
<b>70 025161</b>	Manicotto per tubo ø42 mm. Tube holder ø42 mm.	Ferro zincato / Zinc plated	0,830	1



Codice / Code	ø (mm)	Descrizione / Description	Kg	Pezzi / Pack
<b>70 001133</b>	42	Tappo esterno ø42 mm. / External cap ø42 mm.	0,030	50



Codice / Code	ø (mm)	Descrizione / Description	Kg	Pezzi / Pack
<b>80 KR010</b>	42	Tappo interno ø42 mm. / External cap ø42 mm.	0,030	50



Supporto parafango con alette.  
Mudguards bracket.

Codice / Code	L (mm)	ø (mm)	Descrizione / Description	Kg	Pezzi / Pack
<b>70 025109</b>	750	54	Grezzo / Raw	2,90	1
<b>70 025110</b>	750	54	Zincato a caldo / Hot dip coating	3,30	1
<b>66 0319008/BIS</b>	750	54	Zincato a freddo / Zinc plated	3,30	1
<b>70 025111</b>	750	54	Inox / Stainless	2,80	1
<b>66 0319069</b>	750	54	Inox fiorettato / Stainless steel with texture	2,80	1
<b>70 025158</b>	750	42	Zincato a freddo / Zinc plated	3,50	1



Codice / Code	ø (mm)	Descrizione / Description	Kg	Pezzi / Pack
<b>66 6210022</b>	54	Tappo in PVC per tubo. / PVC cap for tube.	0,010	50
<b>80 KR010</b>	42	Tappo in PVC per tubo. / PVC cap for tube.	0,010	50



Codice / Code	ø (mm)	Descrizione / Description	Kg	Pezzi / Pack
<b>70 025174</b>	42	Aletta zincata per supporto parafango. / Zinc plated bracket	0,244	50



Codice / Code	ø (mm)	Descrizione / Description	Kg	Pezzi / Pack
<b>70 001100</b>	48	Tappo in gomma. / Rubber cap.	0,05	50



Codice / Code	ø (mm)	Descrizione / Description	Kg	Pezzi / Pack
70 025159	42	Manicotto zincato a freddo per supporti. Cold Galvanized tube holder	0,80	1



Codice / Code	ø (mm)	Descrizione / Description	Kg	Pezzi / Pack
70 025155		Manicotto zincato - modello rinforzato per tubo diametro 54 mm. Zinc plated tube holder - Reinforced model for tube diameter 54 mm.	0,089	1



Codice / Code	L (mm)	H (mm)	Descrizione / Description	Kg	Pezzi / Pack
70 025168	190	126	Manicotto grezzo - modello rinforzato, tubo diametro 54 mm. Raw tube holder - Reinforced model, for tubo diameter 54 mm.	1,00	1



Codice / Code	H (mm)	Descrizione / Description	Kg	Pezzi / Pack
70 025161	42	Manicotto in acciaio zincato rinforzato per tubo, diametro 42 mm. Zinc plated tube holder, diameter 42 mm.	0,83	1





Codice / Code	L (mm)	H (mm)	Descrizione / Description	Kg	Pezzi / Pack
<b>66 0319060</b>	800	240	Supporto curvo zincato a freddo ø54 spessore 2 mm, completo di staffe. / zinc plated tube ø54 thickness 2 mm, with wings.	3,55	1



Codice / Code	L (mm)	Descrizione / Description	Kg	Pezzi / Pack
<b>66 0319061</b>	380	Aletta ø54. Bracket ø54. Grezzo / Raw	0,50	1
<b>66 0319062</b>	380	Aletta ø54. Bracket ø54. Zincato a freddo / Zinc plated	0,50	1
<b>66 0319065</b>	380	Aletta ø54. Bracket ø54. Zincato a caldo / Hot dip coating	0,50	1
<b>66 0319063</b>	380	Aletta ø54. Bracket ø54. Inox / Stainless steel	0,50	1
<b>66 0319064</b>	380	Aletta ø54. Bracket ø54. Inox fiorettato / Stainless steel with texture	0,50	1



Codice / Code	L (mm)	Descrizione / Description	Descrizione / Description	Kg	Pezzi / Pack
<b>66 0319074</b>	790	Supporti: tubo diametro 54 mm Brackets: tubo diameter 54 mm.	3 mm grezzo / 3 mm raw	2,5	1
<b>66 0319076</b>	790	Supporti: tubo diametro 54 mm Brackets: tubo diameter 54 mm.	3 mm zincato freddo / 3 mm Zinc plated	2,5	1
<b>66 0319086</b>	790	Supporti: tubo diametro 54 mm Brackets: tubo diameter 54 mm.	2 mm inox / 2 mm stainless steel	1,9	1



Codice / Code	Descrizione / Description
<b>70 025175</b>	Staffa parafanghi registrabile pvc ø 54



Codice / Code	L (mm)	W (mm)	Descrizione / Description	Kg	Pezzi / Pack
<b>70 025112</b>	455	1000	Supporto centrale per parafanghi 2 assi o 3. Tubo centrale ø54 mm - Zincato Central bracket for 2 axes or 3 mudguards. Central tube ø54 mm - Zinc plated	4,10	1
<b>70 025112G</b>	455	1000	Supporto centrale per parafanghi 2 assi o 3. Tubo centrale ø54 mm - Grezzo Central bracket for 2 axes or 3 mudguards. Central tube ø54 mm - Raw	4,10	1

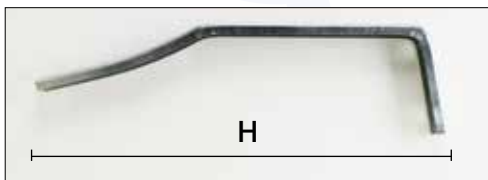

Codice / Code	W (mm)	H (mm)	Descrizione / Description	Kg	Pezzi / Pack
<b>70 025121</b>	35	465	Supporto parafango zincato. / Zinc plated mudguard bracket	0,39	1

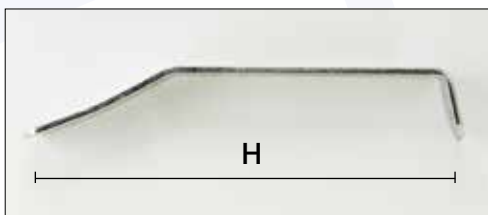

Codice / Code	W (mm)	H (mm)	Descrizione / Description	Kg	Pezzi / Pack
<b>70 025113</b>	40	325	Supporto parafango zincato. / Zinc plated mudguard bracket	0,51	1
<b>70 025114</b>	40	430	Supporto parafango zincato. / Zinc plated mudguard bracket	0,78	1
<b>70 025115</b>	40	510	Supporto parafango zincato. / Zinc plated mudguard bracket	0,81	1
<b>70 025116</b>	40	585	Supporto parafango zincato. / Zinc plated mudguard bracket	1,08	1



Codice / Code	L (mm)	W (mm)	H (mm)	Descrizione / Description	Kg	Pezzi / Pack
<b>70 025117</b>	730	200	30	Supporto quadro zincato. / Square tube, zinc plated	1,80	1



Codice / Code	L (mm)	W (mm)	Descrizione / Description	Kg	Pezzi / Pack
<b>70 001124</b>	30	30	Tappo quadro. / Square cap	0,01	50