

12 FINISSAGGIO FINISHING



V15 - 2024

01. SIGILLANTI • SEALANT
02. SPOILERS
03. PARAINCASTRI • UNDERRIDE PROTECTION
04. GRIGLIE COPRI FANALI • LIGHT GRIDS
05. DISCHI COPRI RUOTE • WHEEL COVERS
06. COPRIBULLONI • NUTCOVER
07. ANTIFURTI • ANTI THEFT SYSTEM



Sigillante monocomponente poliuretano,
310cc
Polyurethane sealant, 310cc

Caratteristiche:

Resistente UV
Temperatura esercizio 30/90°C
Resistente alla trazione 1,8 MPa
Features:
UV proof
Working temperature 30/90°C
Strength 1,8 MPa

Codice / Code	Colore / Colors	Kg	Pezzi Pack
70 073014	bianco white		12
70 073015	grigio gray		12
70 073016	nero black		12
70 073017	testa di moro brown		12



Sigillante bicomponente poliuretano,
2 x 200ml
Two components polyurethane sealant, 2
x 200ml

Caratteristiche:

Rapido indurimento
Colla strutturale 12 MPa
Features:
Fast hardening
Structural adhesive 12 MPa

Codice / Code	Colore / Colors	Kg	Pezzi Pack
70 073018	grigio gray		12



Codice / Code	Colore / Colors	Kg	Pezzi Pack
70 073006	Marothaan grigio	10	1
70 073007	Catalizzatore hardener	1,17	1



66 1117081
Colla per spoilers / Glue for spoilers



Pistola ad aria per cartucce da 310cc
Air gun for 310cc cartridge

Codice / Code	Pezzi Pack
70 073008	12



Realizzati in fibra di vetro colore bianco. Montaggio con collante specifico (66 1117081) incluso
Made of white glass fiber. Fixing glue (66 1117081) included



Realizzati in fibra di vetro colore bianco. Montaggio con staffe incluso
Made of white glass fiber. Mounting brackets included.



Coppia bandelle laterali realizzati in fibra di vetro colore bianco / Side parts kit, fibre glass, white

Codice / Code	Descrizione / Description	H (cm)	Pezzi / Pack
66 1117065L	Sprinter 2006 e 2018 / Crafter fino a 2016	70	1
66 1117066L	Ducato 2006	70	1
66 1117077L	Daily 2000/2014		1
66 1117073L	Master 2010, Mascotte Movano / NV 400	70	1
66 1117076L	Transit 2014	75	1
66 1117074L	Sprinter	38	1
66 1117082L	Spoiler Crafter 2017 / TGE		1
66 1117083L	Spoiler Maxus	63	1

Codice / Code	Descrizione / Description	H (cm)	Pezzi / Pack
66 1117079L*	Daily 2014		1
66 1117056L	Cabstar / Maxcity / NT 400 (Su richiesta / On demand)	75	1
66 1117068L	Daily 2006	70	1
66 1117063	Eurocargo Cab. corta tetto basso	55/85	1
66 1117078L	Nissan NT500 / Renault (Su richiesta / On demand)	95	1
66 1117057L	Isuzu II L.1760	75	1
66 1117069	Sprinter 2006 e 2018 / Crafter fino a 2016	70	1
66 1117052L	Atego	50/80	1
66 1117051L	Canter 2° serie	75	1
66 1117072L	Daily 2006	36	1
66 1117062L	Atleon	80	1

* Non adatto a cabina con fanali Led / * Not suitable for truck cab with Led side marker

Codice / Code	Descrizione / Description	H (cm)	Pezzi / Pack
66 1118014L	Atleon con attacchi		2
66 1118016	Eurocargo corta 2003		2
66 1118017L	Daily 2012		2
66 1118018L	Sprinter fino al 2018 (Su richiesta / On demand)		2
66 1118019L	Daily 2014		2
66 1118020L	Sprinter dal 2019		2



Codice / Code	Descrizione / Description	L (mm)	Kg	Pezzi/Pack
70 060100	Acciaio 20/10 verniciato grigio, cantonale in plastica / Steel 2 mm tk, grey, plastic caps	1800	8,6	1
70 060101	Acciaio 20/10 verniciato grigio, cantonale in plastica / Steel 2 mm tk, grey, plastic caps	1900	9,0	1
70 060102	Acciaio 20/10 verniciato grigio, cantonale in plastica / Steel 2 mm tk, grey, plastic caps	2000	9,6	1
70 060103	Acciaio 20/10 verniciato grigio, cantonale in plastica / Steel 2 mm tk, grey, plastic caps	2100	10	1
70 060104	Acciaio 20/10 verniciato grigio, cantonale in plastica / Steel 2 mm tk, grey, plastic caps	2200	10,6	1
70 060105	Acciaio 20/10 verniciato grigio, cantonale in plastica / Steel 2 mm tk, grey, plastic caps	2300	11,0	1
70 060213	Acciaio 20/10 verniciato grigio, cantonale in plastica / Steel 2 mm tk, grey, plastic caps	2400	11,6	1



Codice / Code	Descrizione / Description	L (mm)	Kg	Pezzi/Pack
70 061100	Acciaio inox fiorettato 20/10, cantonali in plastica / Polished stainless steel 2 mm tk, plastic caps	1800	8,6	1
70 061101	Acciaio inox fiorettato 20/10, cantonali in plastica / Polished stainless steel 2 mm tk, plastic caps	1900	9,0	1
70 061102	Acciaio inox fiorettato 20/10, cantonali in plastica / Polished stainless steel 2 mm tk, plastic caps	2000	9,6	1
70 061103	Acciaio inox fiorettato 20/10, cantonali in plastica / Polished stainless steel 2 mm tk, plastic caps	2100	10,0	1
70 061104	Acciaio inox fiorettato 20/10, cantonali in plastica / Polished stainless steel 2 mm tk, plastic caps	2200	10,6	1
70 061105	Acciaio inox fiorettato 20/10, cantonali in plastica / Polished stainless steel 2 mm tk, plastic caps	2300	11,0	1
70 061176	Acciaio inox fiorettato 20/10, cantonali in plastica / Polished stainless steel 2 mm tk, plastic caps	2400	12,0	1



Codice / Code	Descrizione / Description	L (mm)	Kg	Pezzi/Pack
70 060208	Acciaio inox fiorettato 20/10, cantonali inox ed alzata smussata Polished stainless steel 2 mm tk, inox cap	2300	22,9	1
70 060214	Acciaio inox fiorettato 20/10, cantonali inox ed alzata smussata Polished stainless steel 2 mm tk, inox cap	2400	23,9	1

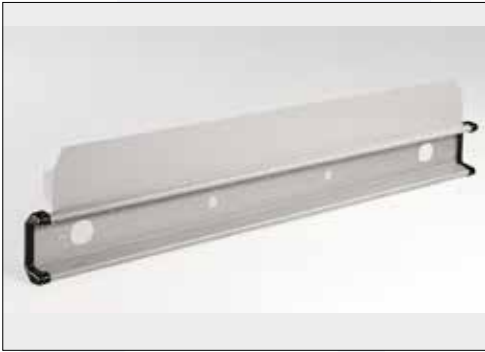

Codice / Code	Descrizione / Description	Materiale / Material	L (mm)	Kg	Pezzi/Pack
70 060212	Traversa portafanali sp. 20/10 con alzata a tappi in plastica Underride protection 2 mm tk with plastic caps	Grigio / Grey	2300	22,7	1
70 060209	Traversa portafanali sp. 20/10 con alzata a tappi in plastica Underride protection 2 mm tk with plastic caps	Bianco / White	2400	21,6	1
70 060210	Traversa portafanali sp. 20/10 con alzata a tappi in plastica Underride protection 2 mm tk with plastic caps	Inox fiorettato / Stainless flowered	2400	22,9	1
70 060211	Traversa portafanali sp. 20/10 con alzata a tappi in plastica Underride protection 2 mm tk with plastic caps	Inox fiorettato / Stainless flowered	2300	23,9	1



Codice / Code	Descrizione / Description	Materiale / Material	L (mm)	Kg	Pezzi/Pack
70 060215	Traversa portafanali daily non omologati (Su richiesta / On demand)	New Daily	1900	10,0	1
70 060216	Traversa portafanali daily non omologati	Daily 2000	1900	10,0	1



Codice / Code	Descrizione / Description
70 060203	Traversa grezza per veicoli pesanti L 2300 10 x 5 Cm Raw Underride protection for heavy load vehicle L 2300 10 x 5 Cm



Codice / Code	Descrizione / Description
70 001119	Cantonale in plastica Plastic cap

Traversa omologata 58r-03 in alluminio L.2400 / Homologated 58r-03 underride protection in aluminium L.2400

Codice / Code	Descrizione / Description	L (mm)	Kg	Pezzi Pack
70 060106	Traversa omologata con staffe lunghe Homologated underride protection with long holders	2400	66,82	1
70 060107	Traversa omologata con staffe corte Homologated underride protection with short holders	2400	54,80	1

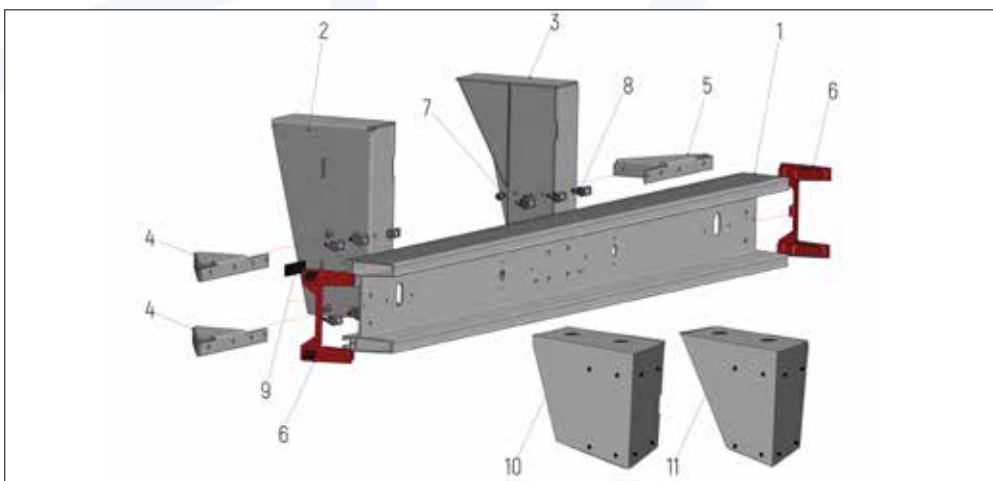

Componenti / Components

Fig.	Codice / Code	Descrizione / Description	Kg	Pezzi Pack
1	70 060108	Traversa in alluminio L.2400 Aluminium underride protection L.2400	23,949	1
3	70 060108/1	Staffa lunga SX grezza 300x400-530mm Long and raw holder 300x400-530mm - Left	16,913	1
2	70 060108/2	Staffa lunga DX grezza 300x400-530mm Long and raw holder 300x400-530mm - Right	16,913	1
11	70 060108/3	Staffa corta SX grezza 300x290mm Short and raw holder 300x290mm - Left	10,860	1
10	70 060108/4	Staffa corta DX grezza 300x290mm Short and raw holder 300x290mm - Right	10,860	1
4	70 060108/5	Rinforzo grezzo SX Raw reinforcement - Left	2,009	2
5	70 060108/6	Rinforzo grezzo DX Raw reinforcement - Right	2,009	2
7-8	70 060108/7	Kit di fissaggio Mounting kit	0,050	1
6	70 060108/8	Tappo nero Black cover cap	0,022	2
9	70 060108/9	Targhetta 120x27 mm con omologazione 58R-03 120x27 mm type plate with ECE marking 58R-03	0,010	1

Istruzioni / Instructions

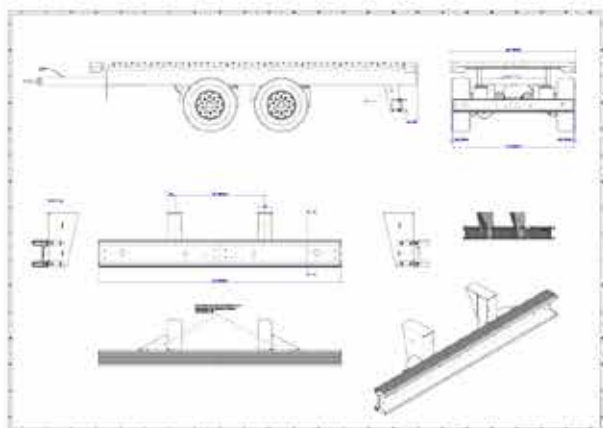

Distanza tra staffe / Frame width: 750 mm - 1000 mm
Rinforzi esterni / External reinforcement

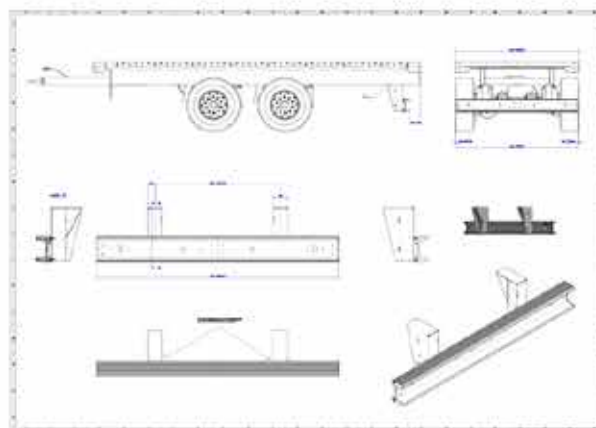

Distanza tra staffe / Frame width: 1001 mm - 1250 mm
Senza rinforzi / Without reinforcement

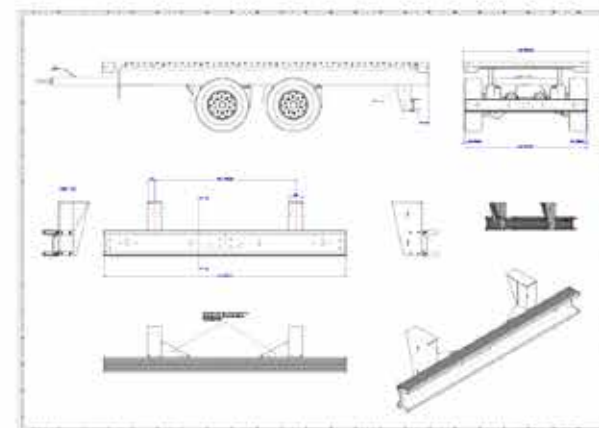

Distanza tra staffe / Frame width: 1251 mm - 1400 mm
Rinforzi interni / Inside reinforcement



Su barra / on Underride protection

Codice / Code	Veicolo / Vehicle	Dimensione / Dimension				Peso / Weight
		A	B	C	D	
70 010110	Daily 1999 e 2012, Eurocargo	330	195			550 g
70 010122	Eurotech, Eurostar	430	200			680 g
70 010132	Eurotech, Eurocargo, Eurostar, Stralis 2003 cab.	500	195			805 g
	Grande, Stralis 2003 ActiveDay e ActiveTime					
70 010141*	Ford Transit	375	195			700 g
70 010135	Daily 2021	370	195			600 g

* fino esaurimento scorte / * Until stocks last

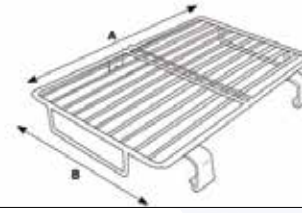

Su barra / on Underride protection

Codice / Code	Veicolo / Vehicle	Dimensione / Dimension				Peso / Weight
		A	B	C	D	
70 010136	Nissan L/M, Eco, Cabstar e Renault Mascotte	375	195			665 g
	2009					

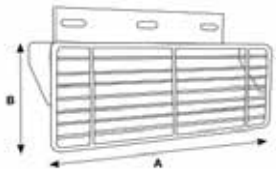

Su barra / on Underride protection

Codice / Code	Veicolo / Vehicle	Dimensione / Dimension				Peso / Weight
		A	B	C	D	
70 010140	Isuzu	350	145			1.030 g

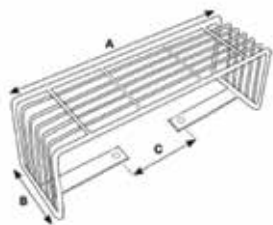

Su barra / On Underride protection
O / OR
Su supporto / On support

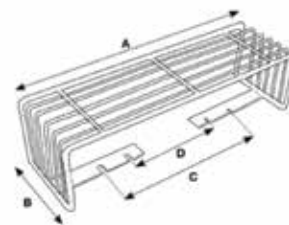

Su supporto / On support

Codice / Code	Veicolo / Vehicle	Dimensione / Dimension				Peso / Weight
		A	B	C	D	
70 010114	Man serie leggero (su barra / on Underride protection)	365	150	150		900 g
	Nissan Trade (su supporto/ on support)					
70 010116*	Actros, Axor (su barra / on Underride protection)	575	160	195		1580 g
70 010118	Mercedes Sprinter (su supporto / on support)	500	145	150		1250 g
70 010127	Mercedes Actros - 2010 / Axor (su supporto / on support)	570	160	195		1580 g
70 010130	Mercedes Atego (su supporto / on support)	500	160	150		1450 g
70 010131	Mitsubishi Canter (su supporto / on support)	380	150	160		900 g
70 010142	Ford Transit 2017 (su barra / on Underride protection)	420	150	160		750 g

Codice / Code	Veicolo / Vehicle	Dimensione / Dimension				Peso / Weight
		A	B	C	D	
70 010117	Ford 2006	410	130	225	140	760 g

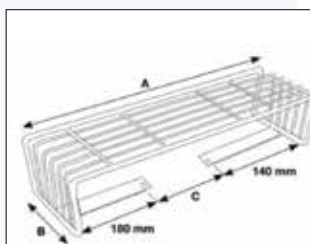

Destro
Right

Su supporto / On support

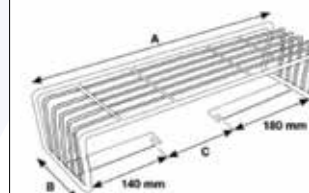

Sinistro
Left

Su supporto / On support

Codice / Code	Veicolo / Vehicle	Dimensione / Dimension				Peso / Weight
		A	B	C	D	
66 4115048	Sprinter 2009 Destro / right	440	160	150		1.050 g
66 4115049	Sprinter 2009 Sinistro / left	440	160	150		1.050 g

* fino esaurimento scorte / * Until stocks last



Su barra / On Underride protection
O / OR
Su supporto / On support

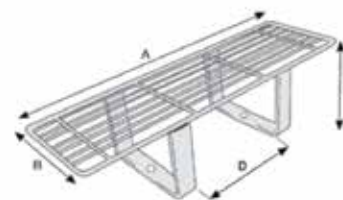

Su supporto / On support

Codice / Code	Veicolo / Vehicle	Dimensione / Dimension				Peso / Weight
		A	B	C	D	
70 010133	Eurotech, Eurocargo, Eurostar, Trakker 2006, Stralis 2003 cab. Grande, Stralis 2003 ActiveDay e ActiveTime (su supporto / on support)	490	155			1240 g
70 010134	Daily 2009 e Daily 2012 (su barra / on Underride protection)	375	195			970 g

Codice / Code	Veicolo / Vehicle	Dimensione / Dimension				Peso / Weight
		A	B	C	D	
70 010129	Scania serie 4 e Volvo FM/FH	525	145	150	145	1270 g

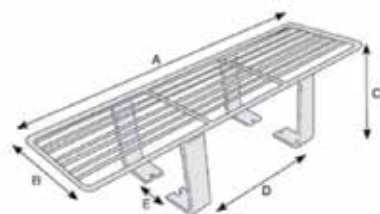

Su supporto / On support

Codice / Code	Veicolo / Vehicle	Dimensione / Dimension				Peso / Weight
		A	B	C	D	
70 010128	Trakker MP410E Serie 1998	470	150	190	60	920 g



Codice / Code	Descrizione / Description	Misura / Size	Kg	Pezzi / Pack
70 064100	Disco Vinci copri ruota inox / Stainless steel wheel cover	Anteriore 20" / Front 20"	1,180	1
70 064101	Disco Vinci copri ruota inox / Stainless steel wheel cover	Posteriore 20" / Rear 20"	1,150	1
70 064102	Disco Vinci copri ruota inox / Stainless steel wheel cover	Anteriore 22" / Front 22"	1,440	1
70 064103	Disco Vinci copri ruota inox / Stainless steel wheel cover	Posteriore 22" / Rear 22"	1,400	1



Codice / Code	Descrizione / Description	Misura / Size	Kg	Pezzi / Pack
70 064111	Disco Rally copri ruota inox / Stainless steel wheel cover	Anteriore 20" / Front 20"	1,450	1
70 064112	Disco Rally copri ruota inox / Stainless steel wheel cover	Posteriore 20" / Rear 20"	1,450	1



Codice / Code	Descrizione / Description	Misura / Size	Kg	Pezzi / Pack
70 064107	Disco Tir 10 fori Ø 33,5 cm / Tir model, 10 holes, Ø 33,5 cm	Verniciato nero Black painted	1,518	1
70 064108	Disco Tir 10 fori Ø 33,5 cm / Tir model, 10 holes, Ø 33,5 cm	Inox Stainless steel	1,175	1



Codice / Code	Descrizione / Description	Misura / Size	Kg	Pezzi / Pack
70 064104	Anello copri ruote inox / Stainless steel hub cover	10 fori / Holes	1,518	1
70 064106*	Anello copri ruote inox / Stainless steel hub cover	8 fori / Holes	1,175	1

* Fino ad esaurimento scorte / Until stock lasts



Codice / Code	Descrizione / Description	Misura / Size	D	H	Kg	Pezzi / Pack
70 064113	Copribullone cromato / Chrome plated nut cover	Chiave 33 Size 33	49,0	49,0	0,018	20
70 064114	Copribullone cromato / Chrome plated nut cover	Chiave 32 Size 32	48,5	46,5	0,016	20
70 064116*	Copribullone cromato / Chrome plated nut cover	Chiave 27 Size 27	36,5	48,5	0,012	20



Codice / Code	Descrizione / Description	Misura / Size	Kg	Pezzi / Pack
70 064118	Indicatore di serraggio ad anello / Wheel nut movement indicator	Ø 32 mm		1
70 064119	Indicatore di serraggio ad anello / Wheel nut movement indicator	Ø 33 mm		1



Codice / Code	Descrizione / Description	Misura / Size	Kg	Pezzi / Pack
70 064120	Copribullone indicatore per ruote con coprimezzo Nut cover indicator for wheels with trims	Ø 32 mm		1
70 064121	Copribullone indicatore per ruote con coprimezzo Nut cover indicator for wheels with trims	Ø 33 mm		1



Codice / Code	Descrizione / Description	Misura / Size	Kg	Pezzi / Pack
70 064122	Copribullone indicatore per ruote senza coprimezzo Nut cover indicator for wheels without trims	Ø 32 mm		1
70 064123	Copribullone indicatore per ruote senza coprimezzo Nut cover indicator for wheels without trims	Ø 33 mm		1

* Fino ad esaurimento scorte / Until stock lasts



Codice / Code	Descrizione / Description	Ø (inch)	Kg	Pezzi / Pack
70 063102 *	Antifurto per semi rimorchio Anti theft for semi trailer	2		1



Codice / Code	Descrizione / Description	Ø (inch)	Kg	Pezzi / Pack
70 063101 *	Antifurto per rimorchio zincato Anti theft for trailer zinc	50	2,650	1
70 063103 *	Antifurto per rimorchio zincato Anti theft for trailer zinc	43	2,400	1



70 063104 *

Antifurto Ø 85 mm. Scania serie 1 - 2 - 3



70 063105

Antifurto zincato Ø 105 mm.



70 063111 *

Antifurto Ø 65 mm.
Renault Premium



70 063115

Coppie ufo automotive completo
di accessori per il montaggio

* Fino ad esaurimento scorte