

Profilo in lega 6005 T6, spessore 30 mm  
Profile in alloy 6005 T6, thickness 30 mm

Codice / Code	L (mm)	W (mm)	H (mm)	Kg/m	Pezzi / Pack
<b>80 0800670</b>	6700	200	30	3,172	1
<b>80 0800750</b>	7500	200	30	3,172	1

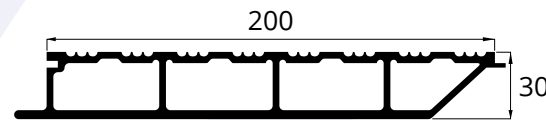
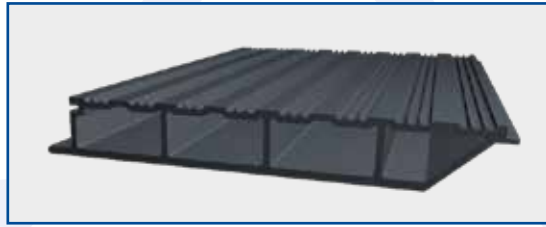

### 80 0801750

Profilo in lega 6005 T6, spessore 30 mm  
Profile in alloy 6005 T6, thickness 30 mm

L (mm)	W (mm)	H (mm)	$\frac{Kg}{m}$	Pezzi / Pack
7500	200	30	3,790	1

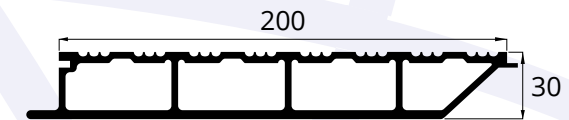
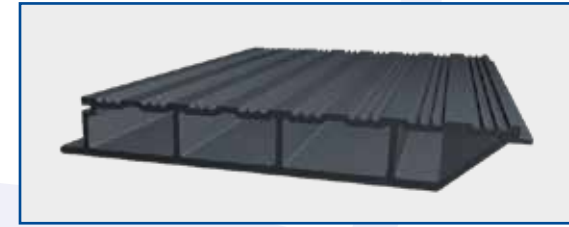

### 80 0801660

Profilo in lega 6005 T6, spessore 30 mm  
Profile in alloy 6005 T6, thickness 30 mm

L (mm)	W (mm)	H (mm)	$\frac{Kg}{m}$	Pezzi / Pack
6600	200	30	3,790	1

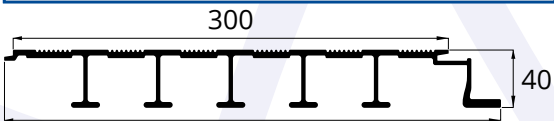

### 80 0803750

Profilo in lega 6005 T6, spessore 40 mm  
Profile in alloy 6005 T6, thickness 40 mm

L (mm)	W (mm)	H (mm)	$\frac{Kg}{m}$	Pezzi / Pack
7500	342	40	6,260	1

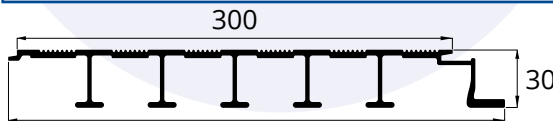

### 342

Profilo in lega 6005 T6, spessore 30 mm  
Profile in alloy 6082, thickness 30 mm

Codice / Code	L (mm)	W (mm)	H (mm)	Kg/m	Pezzi / Pack
<b>80 0804670</b>	6700	342	30	4,530	1
<b>80 0804750</b>	7500	342	30	4,530	1

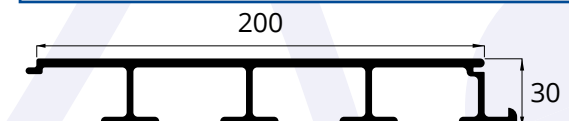

Profilo in lega 6005 T6, spessore 30 mm liscio  
Profile in alloy 6082, thickness 30 mm smooth

Codice / Code	L (mm)	W (mm)	H (mm)	Kg/m	Pezzi / Pack
<b>80 0805750</b>	7500	200	30	2,670	1
<b>80 0805670</b>	6700	200	30	2,670	1

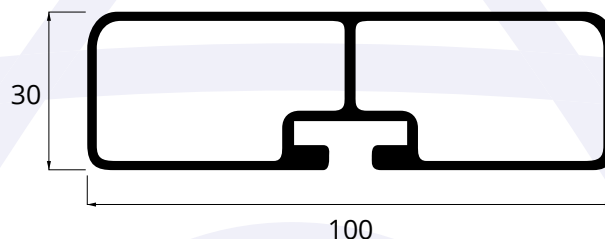

Codice / Code	Descrizione	L (mm)	Kg
<b>80 727500</b>	Profilo parabici	7500	9,430
<b>80 726000</b>	Profilo parabici	6000	8,160
<b>80 723250</b>	Profilo parabici	3250	3,952
<b>80 727500A</b>	Profilo parabici TPA	7500	9,430

### Componenti vari per il montaggio del kit protezione laterale

*Components for kit lateral safety's assembly*



Codice / Code	Descrizione / Description	Pezzi / Pack	Kg
<b>70 050-100</b>	Cantonale in alluminio L=500. <i>Aluminium angle iron L=500.</i>	1	0,500
<b>70 050-101</b>	Cantonale in alluminio L=5200. <i>Aluminium angle iron L=5200.</i>	1	10,000
<b>70 004-100</b>	Tappo in gomma per parabici.	50	0,070
<b>70 004-102</b>	Tappo in gomma per cantonale in alluminio. <i>Rubber cap for aluminium angle iron.</i>	50	0,080
<b>70 050-100V</b>	Cantonale in alluminio verniciato nero L=500. <i>Aluminium angle iron painted black L=500.</i>	1	0,500

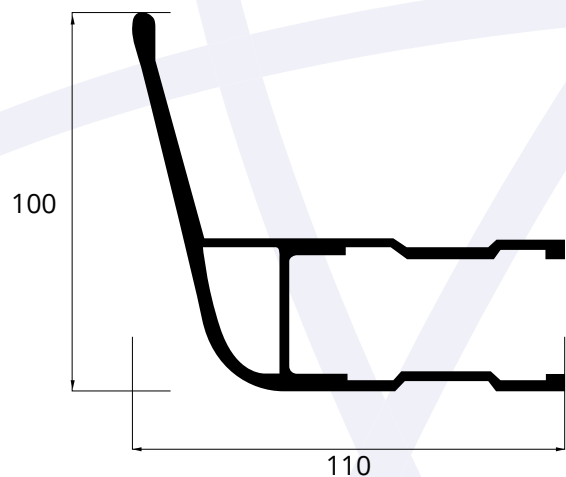

## Componenti vari per il montaggio del kit protezione laterale Components for kit lateral safety's assembly

Codice / Code	Descrizione / Description	Conf. Pz.	Kg
<b>66 0811033</b>	Cantonale in alluminio anodizzato L=6000	1	17,775



Codice / Code	Descrizione / Description	Conf. Pz.	Kg
<b>80KR006</b>	Vite a testa bombata M8x16 per fissaggio alluminio paracicli.	100	1,400
<b>80KR007</b>	Dado autobloccante M8 per 80 KR 006	100	0,600
<b>80KR008</b>	Rondella larga per 80 KR 006	100	1,400

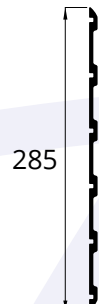

**80.07.50.750**

Profilo battuta anodizzato  
Anodized rabbet profile

L (mm)	W (mm)	H (mm)	$\frac{Kg}{m}$	Pezzi / Pack
7500	3,5	285	2,180	1



**80.07.58.750**

Profilo battuta anodizzato  
Anodized rabbet profile

L (mm)	W (mm)	H (mm)	$\frac{Kg}{m}$	Pezzi / Pack
7500	3,5	30	1,100	1

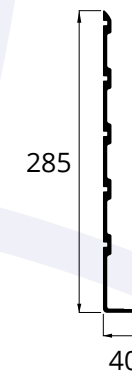

**80.07.51.750**

Profilo battuta anodizzato a L  
Anodized rabbet profile L type

L (mm)	W (mm)	H (mm)	$\frac{Kg}{m}$	Pezzi / Pack
7500	40	285	2,430	1

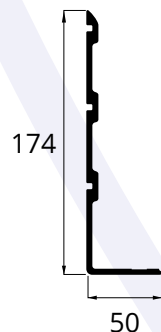

**80.07.59.750**

Profilo battuta anodizzato a L  
Anodized rabbet profile L type

L (mm)	W (mm)	H (mm)	$\frac{Kg}{m}$	Pezzi / Pack
7500	50	174	1,724	1

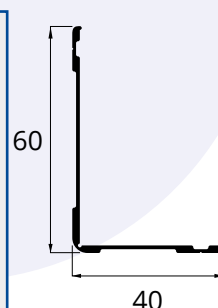

**80.07.54.750**

Profilo per esterno anodizzato  
Anodized outer profile

L (mm)	W (mm)	H (mm)	$\frac{Kg}{m}$	Pezzi / Pack
7500	40	60	0,645	1

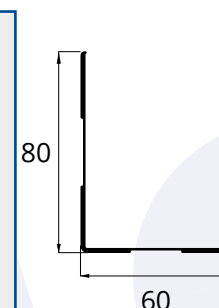

**80.07.55.750**

Profilo per esterno anodizzato  
Anodized outer profile

L (mm)	W (mm)	H (mm)	$\frac{Kg}{m}$	Pezzi / Pack
7500	60	80	0,907	1

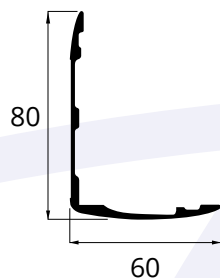

### 80.07.53.750

Profilo angolare anodizzato  
Anodized angle profile

L (mm)	W (mm)	H (mm)	$\frac{Kg}{m}$	Pezzi / Pack
7500	60	80	1,060	1

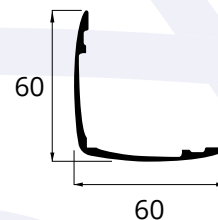

### 80.07.52.750

Profilo angolare anodizzato gobbo per furgoni  
Anodized curved angle profile for vans

L (mm)	W (mm)	H (mm)	$\frac{Kg}{m}$	Pezzi / Pack
7500	60	60	0,660	1

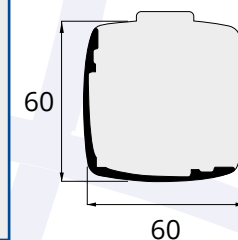

### 80.07.52.000

Calotta angolare gobba Dacromet  
Angle curved crown Dacromet model

L (mm)	W (mm)	H (mm)	$\frac{Kg}{m}$	Pezzi / Pack
60	60	60	0,100	1

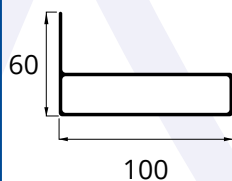

### 80.08.63.760

Profilo reggimensola anodizzato  
Anodized angle bracket profile

L (mm)	W (mm)	H (mm)	$\frac{Kg}{m}$	Pezzi / Pack
7600	100	60	0,290	1

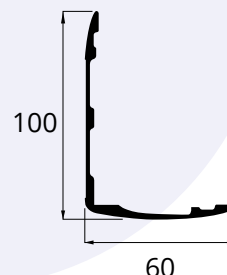

### 80.08.66.750

Profilo angolare anodizzato  
Anodized angle profile

L (mm)	W (mm)	H (mm)	$\frac{Kg}{m}$	Pezzi / Pack
7500	60	100	1,150	1

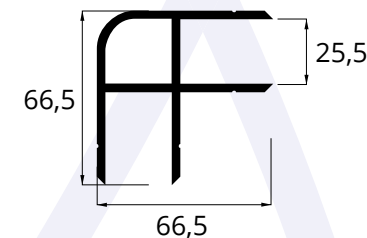

### 80.07.60.760

Profilo cantonale alluminio anodizzato  
Anodized angle profile aluminium

L (mm)	W (mm)	H (mm)	$\frac{Kg}{m}$	Pezzi / Pack
7600	66,5	66,5	1,98	1

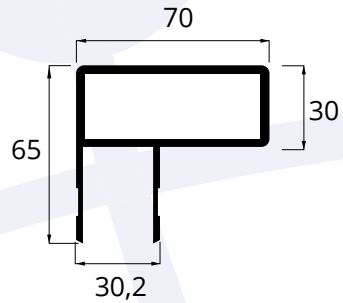

**80.08.65.760**

Profilo anodizzato  
*Corner profile*

L (mm)	W (mm)	H (mm)	$\frac{Kg}{m}$	Pezzi / Pack
7600	3,5	285	1,950	1

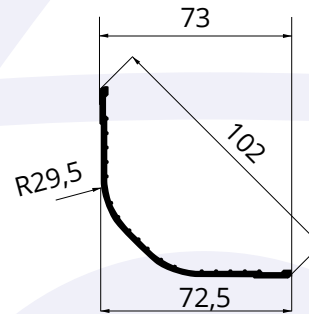

**80.07.57.750**

Profilo cantonale isothermico anodizzato da 102  
*Corner profile anodized, 102*

L (mm)	W (mm)	H (mm)	$\frac{Kg}{m}$	Pezzi / Pack
7500	3,5	30	0,750	1

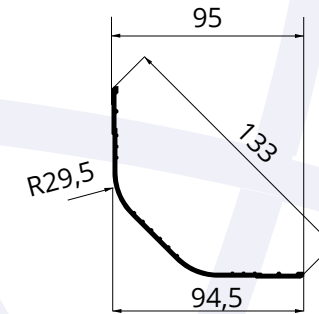

**80.07.56.750**

Profilo cantonale isothermico anodizzato da 133  
*Corner profile anodized, 133*

L (mm)	W (mm)	H (mm)	$\frac{Kg}{m}$	Pezzi / Pack
7500	40	285	0,920	1

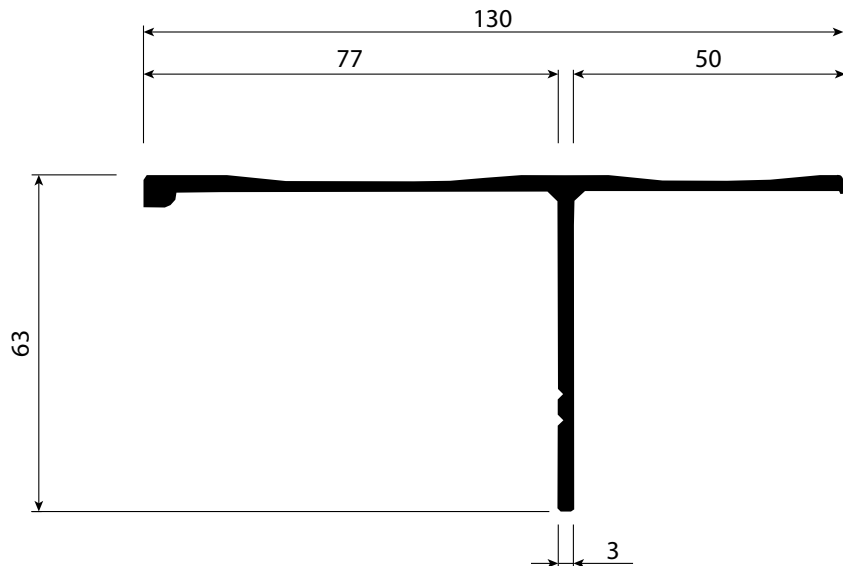

**80.08.67.760**

Profilo per furgonature  
*T-profile, anodized*

L (mm)	W (mm)	H (mm)	$\frac{Kg}{m}$	Pezzi / Pack
7600	63	130	1,430	1

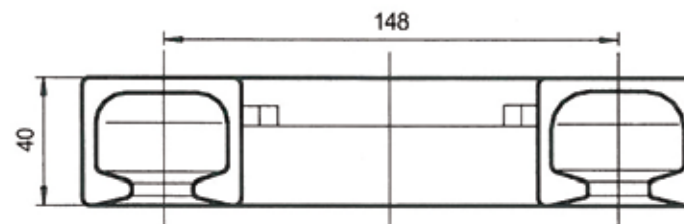
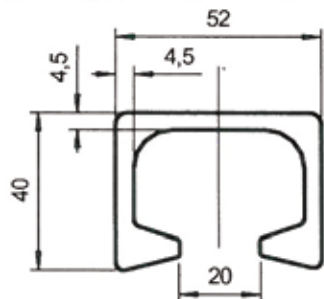

Codice / Code	Descrizione / Description	L (mm)	Kg/m
<b>80.07.71.750</b>	Binario alluminio anodizzato	7500	2,072
<b>80.07.71.750G</b>	Binario alluminio grezzo	7500	2,136

A richiesta curva per raccordo binari alluminio anodizzato (0,750 Kg/m)

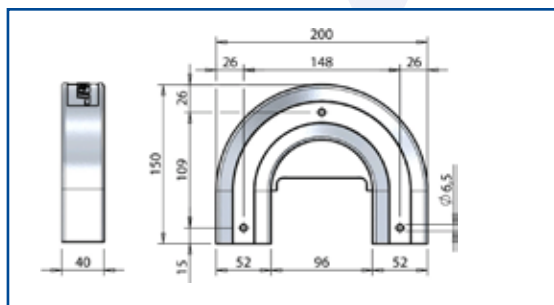

**80 0771751**

Curva per guidovia in alluminio 52x40  
Aluminium curve profile for rail 52x40

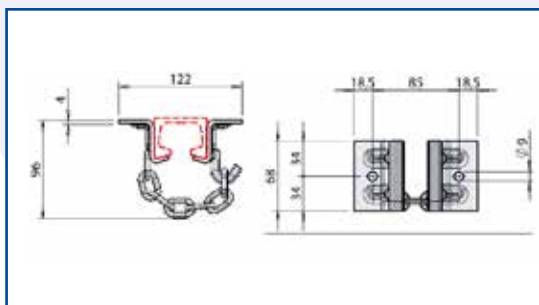

**80 0771752**

Coppia supporti inox fissaggio guidovia c/catena  
Stainless steel support brackets for fixing meat rail  
with chain

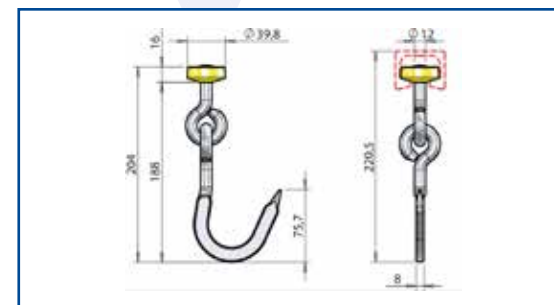

**80 0771753**

Gancio carne snodato inox L. 204 Diametro 12  
Stainless steel flat type, straight hook Ø 12, L. 204